

40-275-004-00



MILLENNIUM SERIES

3L-PIS

TABLE 1: AVAILABLE INSERTS

PART NO.	CONTACT SIZES
3L-PIS-3	3, #10
3L-PIS-4	4, #14
3L-PIS-6	6, #20
3L-PIS-7	7, #16
3L-PIS-8	8, #20
3L-PIS-25	25, #22

3L-PIS-7



3L-PIS

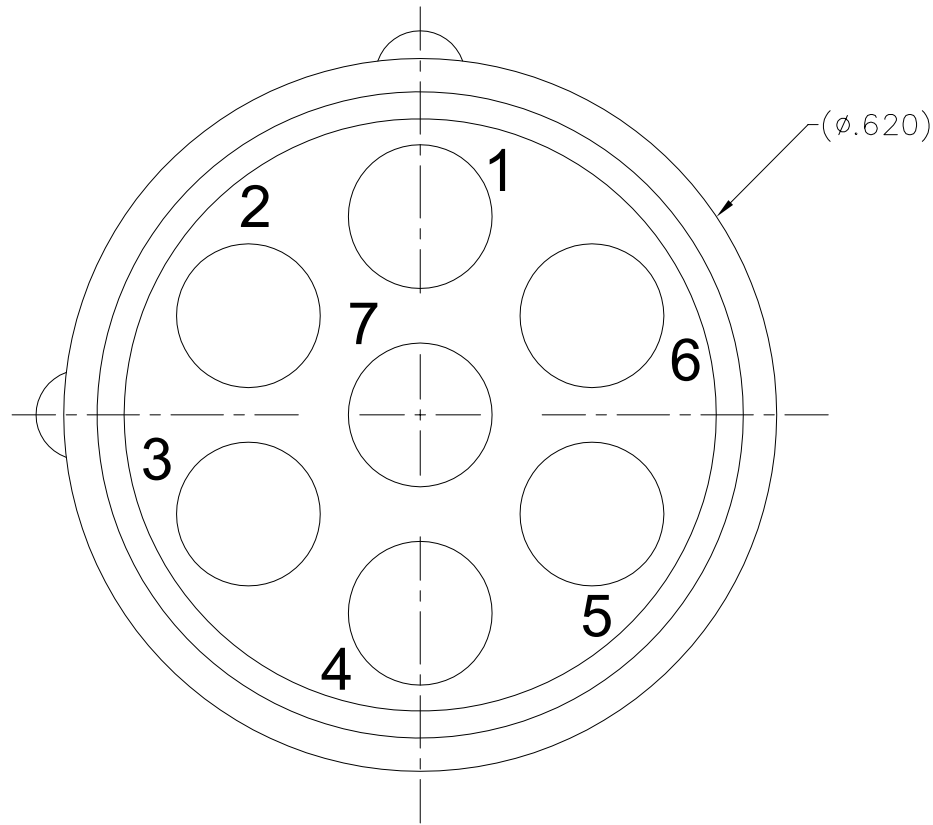

FACE VIEWS

PIN CONFIGURATION

1720 Fiske Place Oxnard, California 93033-1863
 Phone: (805) 487-5393 FAX: (805) 487-0427 Email: service@birns.com
www.birns.com

USA Toll-Free:
 888-BIRNS-88